

NEW

AMERICA

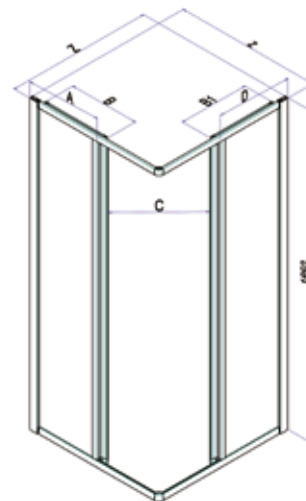

Finitura profili in alluminio:

- LO1** bianco
- ULU** brillantato cromo

Finitura pannelli in vetro temperato:

- TR** trasparente
- ST** stampato

Finitura pannelli in polystyrene:

- JU** Juta

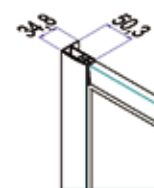
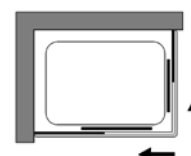

Angolo rettangolare a quattro ante, apertura ad ante scorrevoli, due fisse e due apribili.



Misure (mm.)















DINAMICA_Collection



Articolo	Estensibilità Z [cm]	A [cm]	B [cm]	B1 [cm]	C [cm]	D [cm]	 [dm³]	 [kg]	 [n°]	Pannelli	L01 (€)	ULU (€)
B6830	67-71/83-87	33,8-37,8	32	40	40	41,8-45,8	164	30	1	TR	381	451
										ST	393	464
										JU	379	450
B6838	67-71/87-91	33,8-37,8	32	42	42	43,8-47,8	247	35	1	TR	397	481
										ST	409	495
										JU	396	481
B6896	67-71/97-101	33,8-37,8	32	47	46	48,8-52,8	195	33	1	TR	412	510
										ST	424	526
										JU	412	511
B6897	67-71/107-111	33,8-37,8	32	52	51	53,8-57,8	215	35	1	TR	422	524
										ST	436	540
										JU	423	523
B6898	67-71/117-121	33,8-37,8	32	57	54	58,8-62,8	235	35	1	TR	431	533
										ST	443	549
										JU	429	532
B6825	73-77/77-81	36,8-40,8	35	37	43	38,8-42,8	158	31	1	TR	381	449
										ST	392	463
										JU	380	448
B6824	73-77/87-91	36,8-40,8	35	42	45	43,8-47,8	186	32	1	TR	392	462
										ST	403	476
										JU	389	461
B6850	73-77/97-101	36,8-40,8	35	47	48	48,8-52,8	192	33	1	TR	399	494
										ST	411	510
										JU	398	493
B6840	77-81/97-101	38,8-42,8	37	47	50	48,8-52,8	192	35	1	TR	402	498
										ST	414	514
										JU	401	497
B6899	77-81/117-121	38,8-42,8	37	57	58	58,8-62,8	247	36	1	TR	442	548
										ST	455	565
										JU	440	547

Tempi di consegna	1-2 settimane	2-3 settimane	3-4 settimane
-------------------	---------------	---------------	---------------

Per il trattamento StarClean considerare un aumento di una settimana dei tempi di consegna

Prodotti Speciali							
MISURE LIMITE: Altezza max 200 cm. / Larghezza max 130 cm. / Larghezza min 50 cm. LARGHEZZE INTERMEDIE: sommare al prezzo della misura superiore.							
Tipo (Livello)	STANDARD	Forme SPECIALI				Descrizione	(€)
Livello 1						ALTEZZA inferiore ALTEZZA superiore LARGHEZZA inferiore LARGHEZZA superiore	100
Livello 2						ALTEZZA inferiore / LARGHEZZA inferiore ALTEZZA superiore / LARGHEZZA inferiore ALTEZZA inferiore / LARGHEZZA superiore ALTEZZA superiore / LARGHEZZA superiore	125
Livello 3						VETRO sopra muretto VETRO sagomato VETRO ritagliato FORME SPECIALI	140
Livello 4	SOLUZIONI DIVERSE da quelle contemplate nei livelli 1, 2 e 3: si veda la sezione dedicata da pag. 19 a pag. 41					CONTATTARE UFFICIO CLIENTI per avere la fattibilità e il prezzo	//

Modulo di richiesta disponibile on-line sul sito: www.samo.it/it/prodotti-speciali - In caso di annullamento dopo l'accettazione, sarà addebitato il costo totale dell'ordine.

Codice	Trattamento Vetri	Descrizione	(€)
DF	StarClean	Trattamento vetro anticalcare	100€

Codice	Installazione cabina doccia	Descrizione	(€) prezzi netti	
KU7000.01	Montaggio cabina doccia	Uscita e installazione 1 parete	da 0-100 cm	130
KU7000.11			da 100-200 cm	170
KU7000.03	Montaggio cabina doccia	Uscita e installazione di 2 pareti	da 0-100 cm	150
KU7000.33			da 100-200 cm	190
KU7000.10	Montaggio cabina doccia	Uscita e installazione di 3 pareti	da 0-100 cm	200
KU7000.20			da 100-200 cm	250
KU4000.01	Rilevazione misure	Uscita e rilevazione delle misure	60	